



ROMAN BLIND MEGA  
Lt. BEIGE

Width	Height	Item#
36"	Upto 84"	0063972-0180
42"	Upto 84"	0063973-0180
48"	Upto 84"	0063974-0180
54"	Upto 84"	0063975-0180
60"	Upto 84"	0063976-0180

# Quilted ROMAN BLINDS

Controls Daylight | Reduces unwanted heat gain  
 Minimizes cold drafts near windows | Reflects heat & acts as thermal Insulator  
 Control Style: Chain / Chainess Motorized with Remote control / Alexa, Google Home

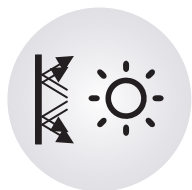

Thermal & Heat Reflective



Motorize Automation  
Compatible



Child Safe

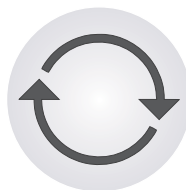

Easy Rotate Eject



High Gear Ratio  
& Lesser Effort

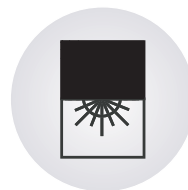

100% Black Out

Amilada Dox Voilet



Width	Height	Item#
36"	Upto 84"	0063967-0464
42"	Upto 84"	0063968-0464
48"	Upto 84"	0063969-0464
54"	Upto 84"	0063970-0464
60"	Upto 84"	0063971-0464

Ivory



Width	Height	Item#
36"	Upto 84"	0063967-0003
42"	Upto 84"	0063968-0003
48"	Upto 84"	0063969-0003
54"	Upto 84"	0063970-0003
60"	Upto 84"	0063971-0003

Easy Upgrade To Motorize

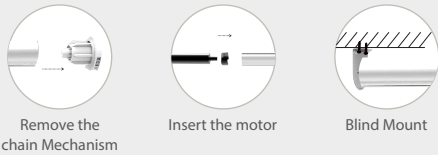

Blind Features

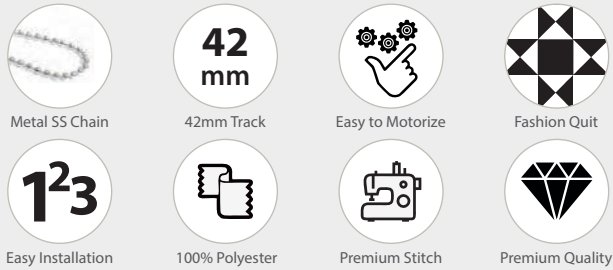

35mm Standard Motor (Optional)



Features

- Voltage 12V
- Weight Capacity 30kg
- Diameter 35mm
- Torque 3Nm
- Noise Low
- 12V Rechargeable Battery Wand
- 3 Rd Party Automation Compatible
- Dimension : L 443mm x dia 22mm

Complete Set

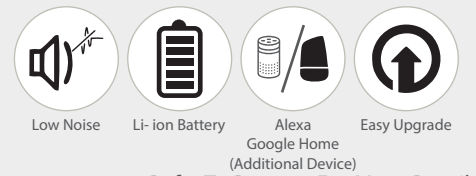
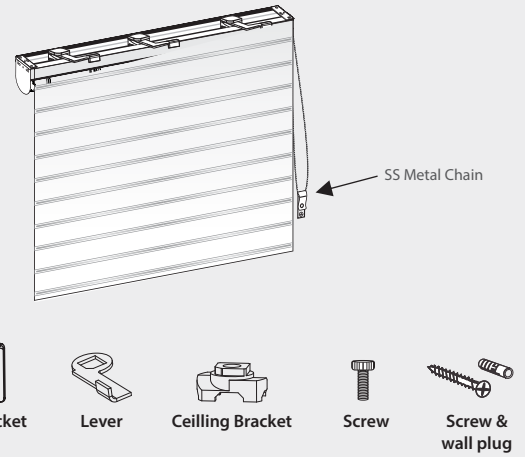

Refer To Page 76 For More Detail